

**MVB BASED GRAPHICAL DRIVER DISPLAY 10.4 INCH SIZE
FOR
WAG9/WAP7/WAP5 CLASS LOCOMOTIVES**

ARC/DDU/V2

USER MANUAL

ADVANCED RAIL CONTROLS PRIVATE LIMITED

#59/1-2, II FLOOR (ABOVE BANK OF INDIA)

G-BLOCK, SAHAKARANAGAR

BANGALORE-560 092

JUNE 29, 2012

RELEASE 1.0

1.0 SCOPE

This document describes the technical details of Graphic Driver Display Unit (DDU) used in 3-Phase Electric Locomotives of WAP5, WAP7, WAG9 & WAG9H classes being operated by Indian Railways. The DDU is a man machine interface device able to communicate with locomotive control system through MVB. The LED backlit 10.4" SVGA LCD screen provides better readability even during daylight conditions, thanks to brightness control. The DDU has various pre-defined screens which can be used for investigative monitoring.

This Driver Display will work with the following versions (or above) of the locomotive software. It will not work with a lower version of locomotive software.

Locomotive Type	Software Version
WAP5	1103
WAP7	2103
WAG9	3103
WAG9H	4103

2.0 KEY DESIGN FEATURES

The key design features incorporated in this DDU are listed below.

SL No	Features	Values/Conformance
1	LCD Display Size	10.4 inch
2	Overall outer dimensions	316x214x108 mm
3	Brightness Control	Available
4	Multiple Screen selection	Available
5	Pre-loaded GIS information of Indian Railway Routes with route mapping application	Will be available in future
6	MVB Connectivity	Available
7	RS422 Connectivity to DDA	Available
8	PIXY Screen Zooming	Available
9	USB Interface	Available
10	Interface for external GPS Receiver	Available
11	Ingress Protection	Totally enclosed (IP65)
12	Cooling	External Fan with chassis cooling
13	Keypads	Function Menu Keys & PIXY screen keys arranged in separate groups
14	Type of Keys	High reliability tactile switches totally sealed using custom made silicon keypad
15	LCD screen resolution	800x600
16	LCD screen temperature range	-30 to +85 degree C
17	Normative Standard Conforming	IEC-60571

3.0 MECHANICAL DESIGN

The driver display is made out of Aluminium material and exterior is hard anodised black. The special function keys and PIXY screen keys are located on the right side of the facia. The USB interface is provided on the right side top, just above the special function key pad.

The rear side of the driver display uses a milled structure with in-built heat sink for chassis cooling. Over the heat sink on the rear side houses a cooling fan (12V DC). The heat generated internally by the heat producing elements like the DC-DC converters and processor is directly transferred to the chassis. The heat generated by other small components is transferred to the chassis indirectly through convection using internal circulating fan. The external fan

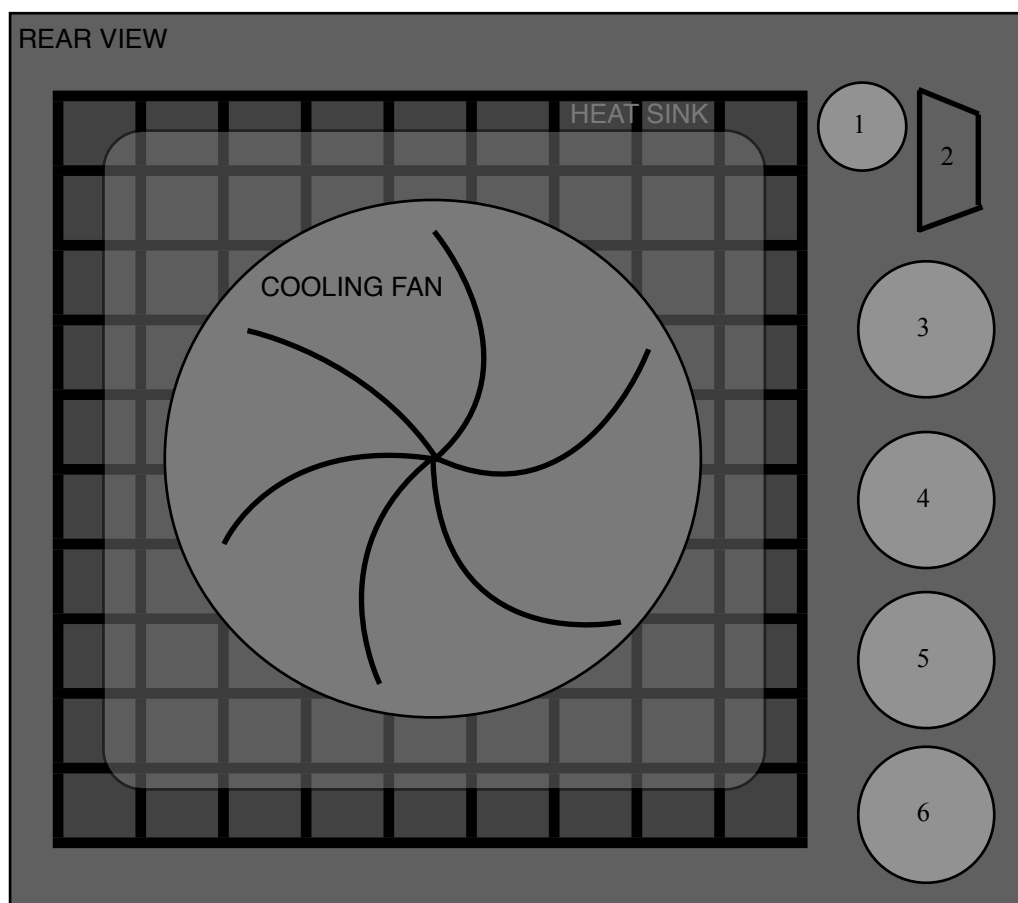

mounted on the heat sink removes the heat from the chassis and maintains the temperature rise under control. All the field interface connectors are terminated on the rear plate on the left side as shown in Figure above.

SL No	Interface Details	Connector Type
1	Key Board	PS2 Female (only for service engineer)
2	DDA (1/2) RS422	9 Pin Sub-D Female
3	MVB	10 Pin Circular Male (ITT KPSE00F12-10P)
4	External GPS	10 Pin Circular Female (ITT KPSE00F12-10S)
5	External Fan Supply 12V DC	3 Pin Circular Female (ITT KPSE00F12-3S)
6	Power Supply 110V DC	3 Pin Circular Male (ITT KPSE00F12-3P)

The equipment can be directly mounted on the C-Panel using screws and the fully assembled C-Panel can be mounted on the driver desk. The mechanical dimensional drawings and mounting instructions are given at the end.



4.0 Operator Controls

The Driver Display has two sets of keypads positioned in different clusters. One set is known as “PIXY” display control key pad & another is known as “Function” keypad. The PIXY control keypad has 8 keys and provides exactly the same control as being done in the old type of 4x40 text display. The “Function” keypad has 6 keys, each assigned to a separate function.

4.01 PIXY Display Control

The pixy display control keypad has 08 tactile keys of rugged type. The keys are protected from direct ingress of dust and moisture using a silicon rubber mould. As the rubber protective membrane is very soft, care must be taken to avoid use with sharp materials. The keys are suitable for operation by fingers. The function assigned to each key is given below.

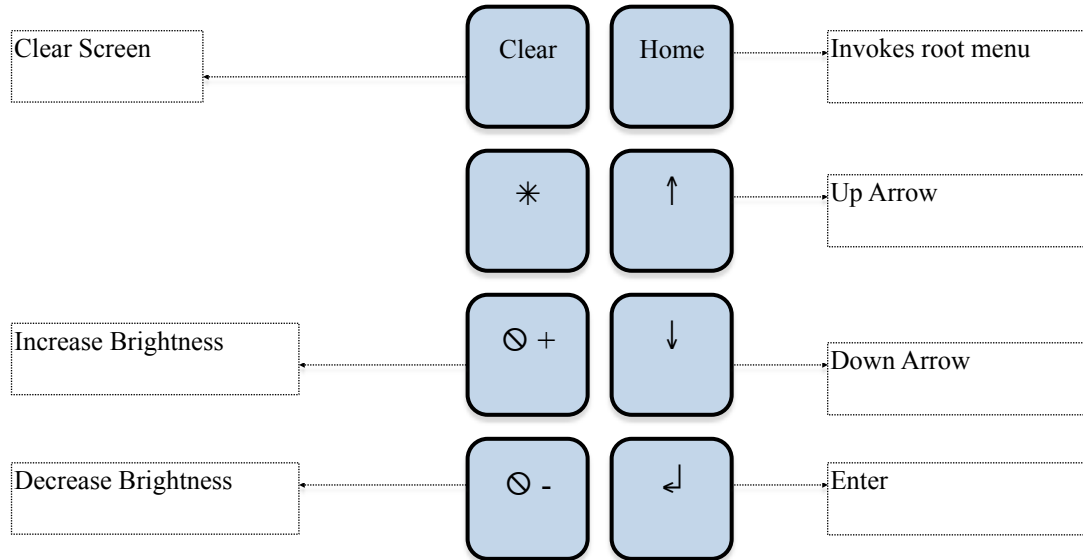

4.02 Function Keys

The function keys are 06 in number and are used for invoking special functions and screens as detailed below.

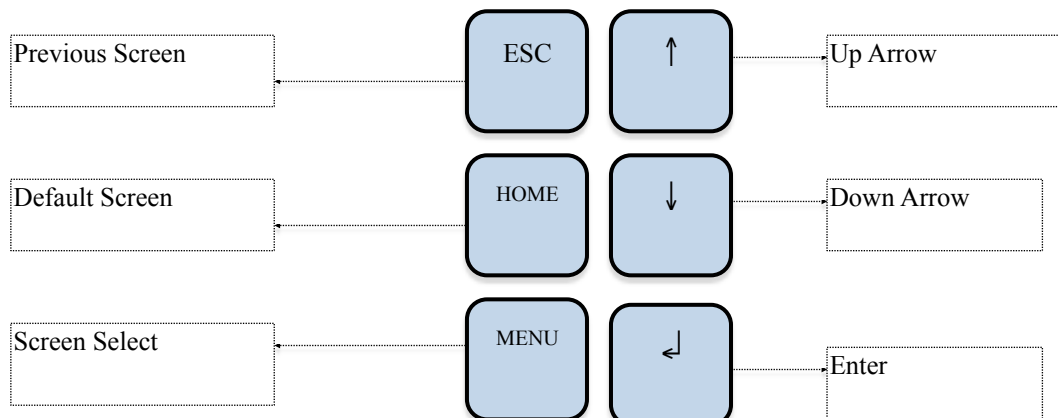

5.0 Screens

The Driver display has pre-defined dedicated screens in order to monitor real time process variables pertaining to a particular section or sub-system of the locomotive. However, such screens are meant for online monitoring by technical staff whenever required. The locomotive driver, however, needs to

view the default screen only most of the times. The screens have been designed to take care of the specification requirement. The details of the screens are explained below.

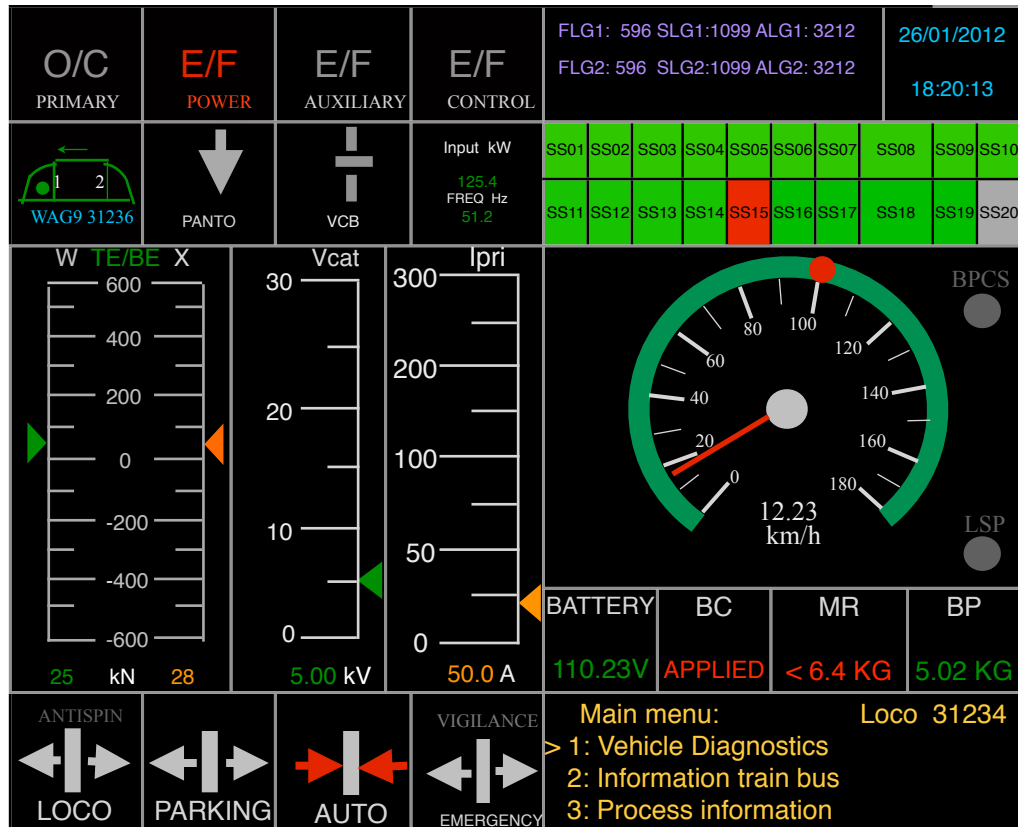

The design philosophy followed is such that all the critical process variables and PIXY screen which are needed to be monitored always by the driver has been provided in a permanent screen area and it will always be available irrespective of any pre-defined screen selected. In any screen, the changing portion is a small area in the space of the speedometer dial of the default screen. This is because, locomotive speed can be monitored through other means also (example: standalone speedometer or the speed in the loco speed available on PIXY screen).

5.01 Default Screen (Screen 1)

The driver normally uses the default screen while driving, even though, he can navigate to any other investigative screens, if required. This screen is divided into various sections. The top left portion gives the status of protective relays. When acted, the colour changes to red. Under normal conditions, the colour is not highlighted and gives a gray colour.

The middle top provides a window in which processor node numbers are displayed (FLG, SLG & ALG). Right top corner displays current date and time. Please note that the date and time shown are from the driver display

processor RTC. In case loco time is needed, the same can be viewed in the PIXY window.

The first graphic mimic in the second row shows the loco type and loco number at bottom, the active cab and the direction selected. The active cab is indicated by a small green dot and the arrow indicates the direction selected.

The second graphic mimic displays the status of pantograph. A block arrow is used to represent the pantograph. When both the pantographs are down, the arrow looks down in gray colour. When any one panto is raised, the arrow points upwards with green colour.

The VCB is represented by three line segments. The notation used is similar to the one used for opening and closing the VCB at OHE neutral sections. When the VCB is OFF, the upper and lower line segments are vertical, middle segment is horizontal and the colour is gray. When the VCB is closed, all the three line segments becomes vertical with green colour.

Right of the VCB mimic is the area for displaying input power and line frequency. Input power displays the instantaneous power at pantograph, calculated by ALG in kW. The Line frequency is also measured by ALG in Hz.

In the second row right side is the sub-system status. There are 19 sub-systems in three phase locomotive. The sub-system 20 does not exist and is retained for getting symmetry of the screen but always remain in gray colour. If a sub-system is isolated, the colour will change to red. A healthy sub-system will be in green colour. For getting the name of the sub-system, Screen-2 can be activated.

The third row is split into two vertical halves. The left portion has three vertical meters viz. TE/BE, Catenary Voltage & Primary Current. The TE/BE meter provides demand (W) set on left side. Actual (X) value realised is shown on the right side, which is a very good scale for comparison. The actual numerical value appears at the bottom. Please note that during bad track conditions, Demand (W) and Actual (X) can vary widely, especially during wheel slip conditions.

The catenary voltmeter shows the catenary voltage (0 to 30kV normal reading). During over voltage and under voltage, the colour of the numerical reading changes to red.

The primary current is shown in a 0 to 300A scale.

The right half side of row 3 of the display is again split into two horizontal portions. The upper portion shows the speedometer mimic. The driver display reads the loco type from the MVB (WAG9/WAG9H/WAP7/WAP5) and accordingly adjusts the maximum speed limit range. The portion upto the maximum limit is shown in green colour and above the speed limit is shown in red colour. In WAG9/9H locomotives, the speed limit is 100 km/h and in WAP5/WAP7, the speed limit is 130 km/h. These figures are automatically adjusted based on the loco type. The numerical value of the speed in km/h is displayed at the bottom.

In the right side of the speedometer dial area, an indication is given for the constant speed operation. When driver presses the constant speed button BPCS, this indication turns green. When not in constant speed mode, the colour is gray.

Within the same speedometer dial area right bottom corner, an indication for wheel slip (LSP) is provided. When there is wheel slip, this indication turns orange, otherwise, the colour is gray.

Below the speedometer dial, four process variables are displayed viz. battery, BC, MR & BP.

The battery voltage, when normal, will be shown in green. When the value goes below 86V, it will be shown in red.

The brake cylinder pressure (BC) is shown in boolean form as 'applied' or 'released' depending upon the brake cylinder pressure.

Similarly, MR pressure is also shown in boolean form. When MR pressure builds up above 6.4 kg/sq.cm, it is shown in green and when it goes below 6.4 kg/sq.cm, it is shown as red.

For brake pressure, absolute analogue value is displayed, which varies from 0 to around 5.6 kg/sq.cm. When the value is above 4.8 kg/sq.cm, it means that the brakes are in released condition and the value will be shown in green. Below 4.8 kg/sq.cm, it is a brake applied condition and hence will be shown in red.

The bottom most row has two portions, the left half shows brake status and the right half is dedicated for the PIXY terminal display.

The loco brake status is shown as 'LOCO'. When the loco brake is not applied, the mimic will be shown in gray colour and arrows pointing away. When loco brake is applied, it turns red and arrows pointing inwards. When anti slip (anti spin) brakes comes into action, the text 'ANTISPIN' above the loco brake mimic will light up in red.

The train brake application is represented by a mimic named 'AUTO' which represents auto brake. When not applied, the arrows are gray and pointing away. When brakes are applied, the colour turns red and arrows pointing inwards.

During emergency brake application, the corresponding arrows turns red and points inwards. In release condition, the arrows are gray and pointing outwards.

ZOOM FUNCTION IN PIXY SCREEN

While in default screen, when <enter> key is pressed in the function key pad (upper group of key pad), the PIXY screen will zoom in to full screen. In the zoomed condition or in the normal condition, all the functionalities are available through the PIXY key pad (bottom group of keys). Pressing <HOME> in the upper group keypad will restore the original screen.

NAVIGATION TO OTHER SCREENS

While in default screen (screen-1), when <menu> button is pressed in the upper group keypad, a new screen will appear in the place of speedometer dial. The speedometer portion has been sacrificed here to give a menu of pre-defined screens that can be viewed. Please note that the Driver will normally drive using default screen only. Other sub-screens are needed for investigative purpose. There are 14 pre-defined screens presently catered.

LIST OF SCREENS

In the above condition, if <HOME> button is pressed, default screen will appear. When the list of screen is displayed, one can navigate to a particular screen by pressing <UP> or <DOWN> arrow keys of the upper group of key pads. After selecting the particular screen, when <ENTER> is pressed, the contents of the selected screen will get displayed. Again by pressing <ESC> will take the menu one level up till the list of screens. Thereafter, by pressing <HOME> in upper group, default screen will appear. Even from any sub-menu, when <HOME> is pressed in the upper group, default menu will appear.

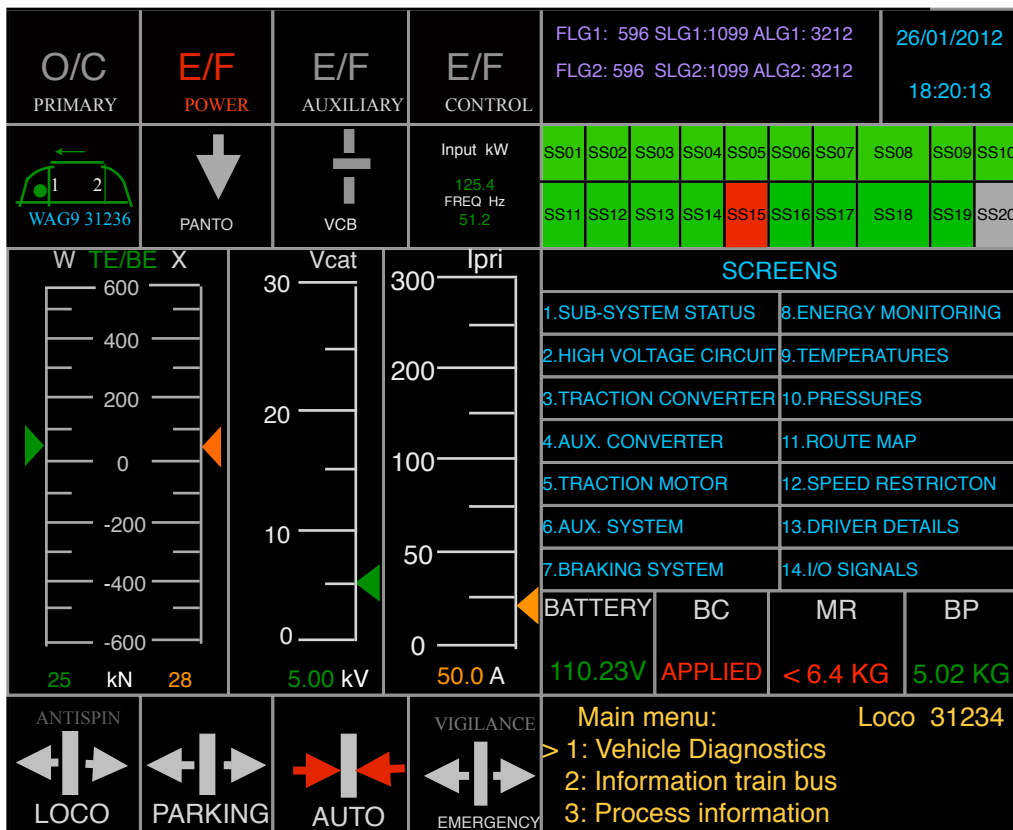

SCREEN 2.1 : SUB-SYSTEM STATUS

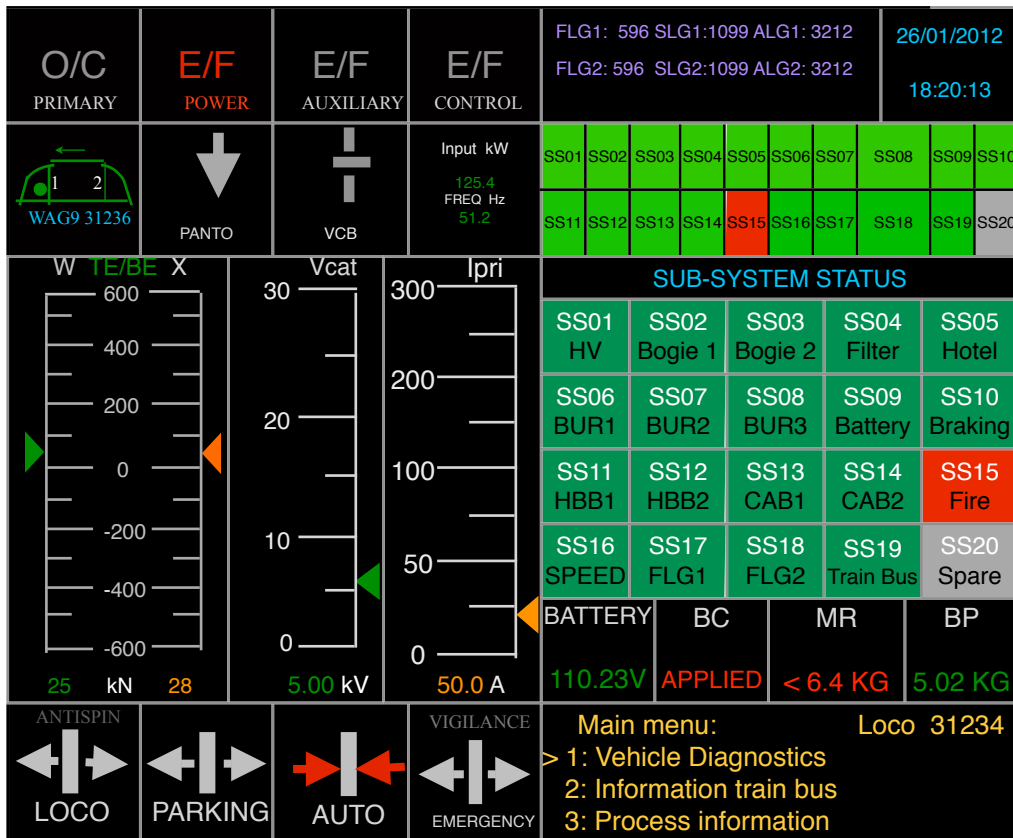

In the sub-system status menu, the names of the sub-systems are listed. To navigate to default screen, press <HOME>. To navigate to list of screens, press <ESC>. The isolated sub-system will be shown in red.

SCREEN 2.2: HIGH VOLTAGE CIRCUIT

In the **HIGH VOLTAGE CIRCUIT** screen, Harmonic Filter status and Hotel Load status are additionally provided. Other variables are already available in the default screen. Hotel Load facility is available only in WAP7 & WAP5 class of locomotives.

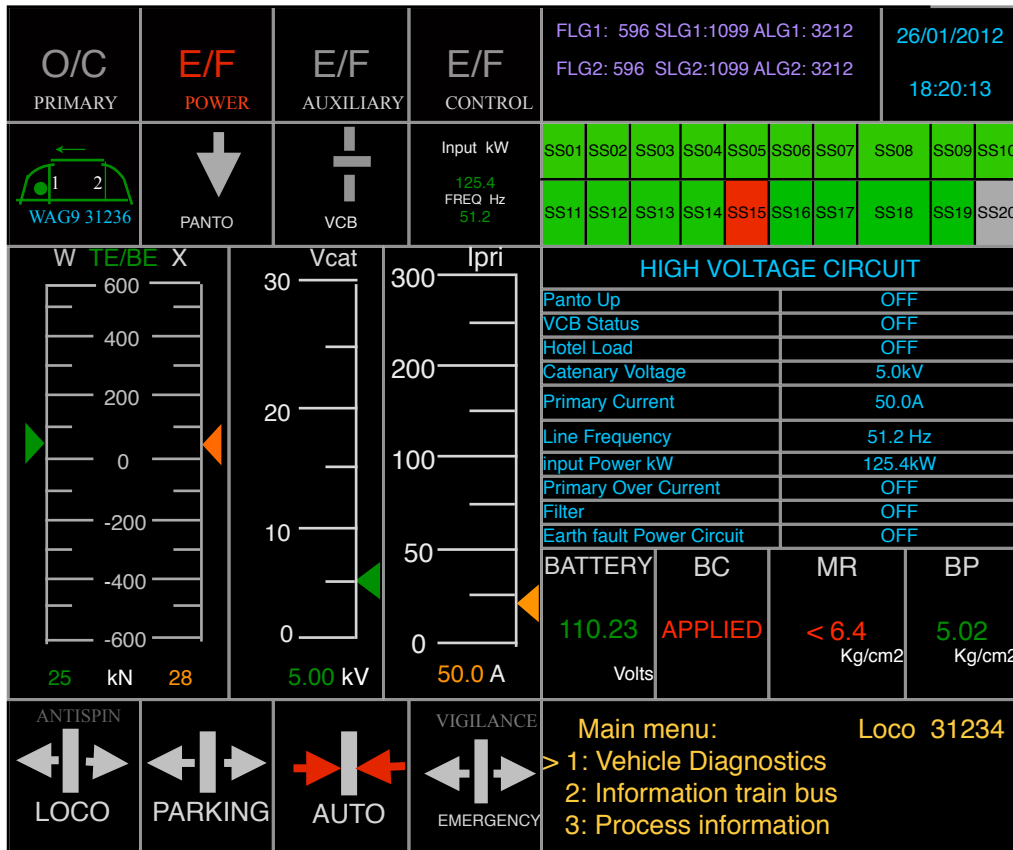

SCREEN 2.3 : TRACTION CONVERTER

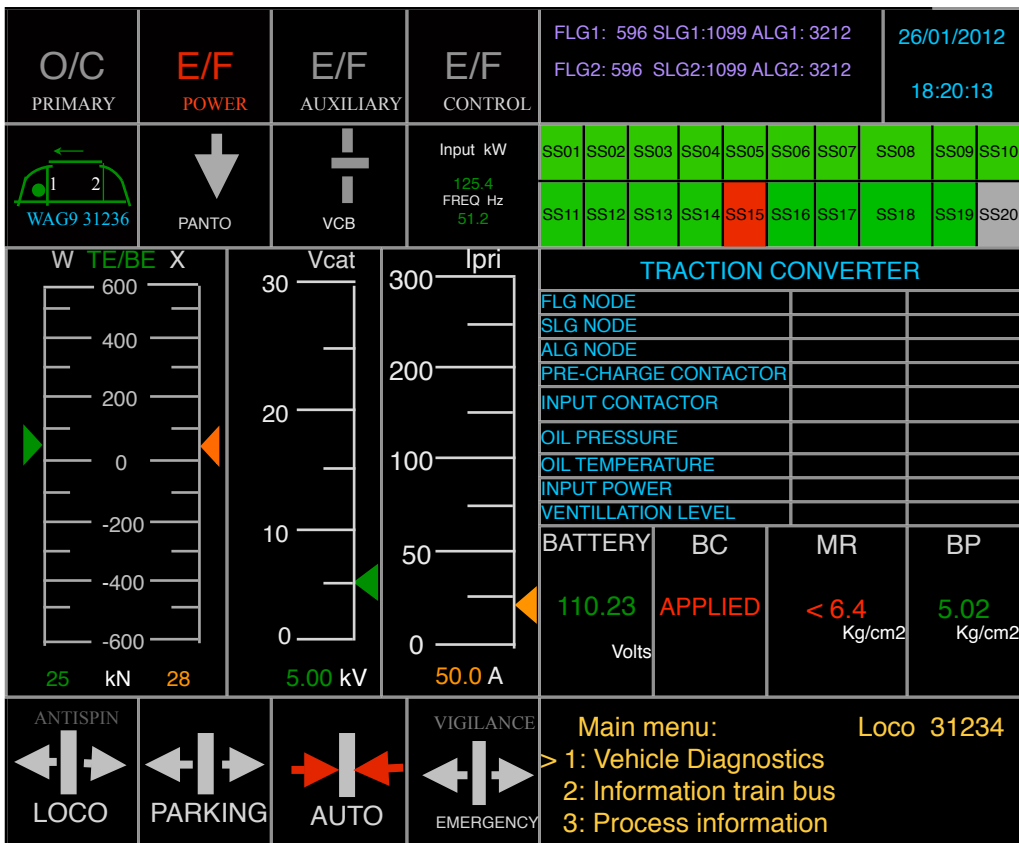

In **TRACTION CONVERTER** screen, converter related parameters are displayed. The screen is split into two columns, one for each traction converter. The process variables displayed include pre-charge & input contactor status, oil pressure & temperatures, input power & ventilation level. Other displayed parameters are already available on default screen.

SCREEN 2.4 : AUXILIARY CONVERTER

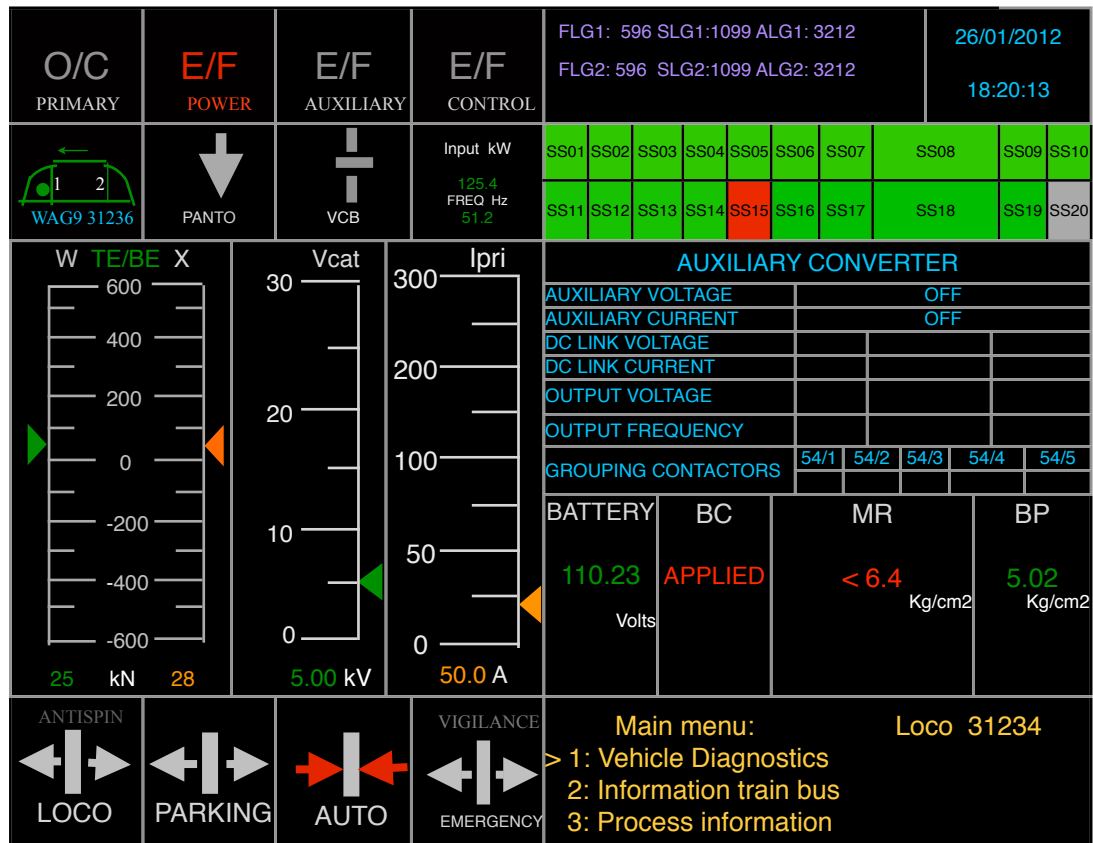

The Auxiliary Converter screen provides very vital process variable display about the BUR, which will help in easy trouble shooting. The variables include Auxiliary winding voltage, Total current in the auxiliary winding, dc link voltage & dc link current of each BUR, output voltage and output frequency. Please note that there is no direct signal available for the output voltage whereas the displayed value is calculated from dc link voltage and output frequency considering constant v/f relation. The screen also provides the status of BUR grouping contactors.

SCREEN 2.5 : TRACTION MOTOR

The traction motor screen is also vertically split into two columns, one for 3 motors belonging to one bogie. The relevant process variables like input contactor status, dc link voltage, ventilation level, converter input power, wheel slip status, speed of each traction motor reported from speed sensor

and temperature of each traction motor reported by the temperature sensor are displayed.

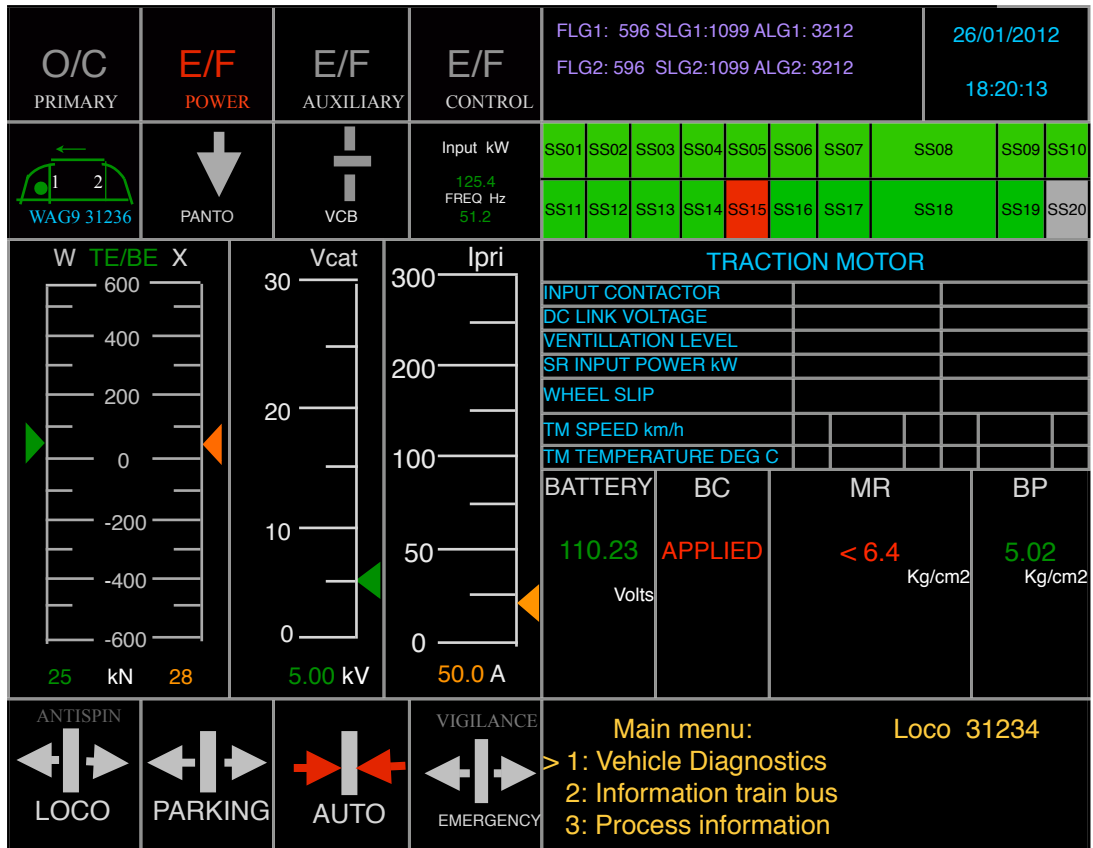

SCREEN 2.6 : AUXILIARY SYSTEM

The auxiliary system screen essentially displays the status of various auxiliary machines, as to whether these are OFF or ON. It also indicates the BUR status and BUR input volatge. The auxiliary machines considered are Compressors (1,2), Oil Cooling Blowers (1,2), Oil Pump Converter (1,2), Oil Pump Transformer (1,2), Traction Motor Blower (1,2) & Machine Room Blower (1,2).

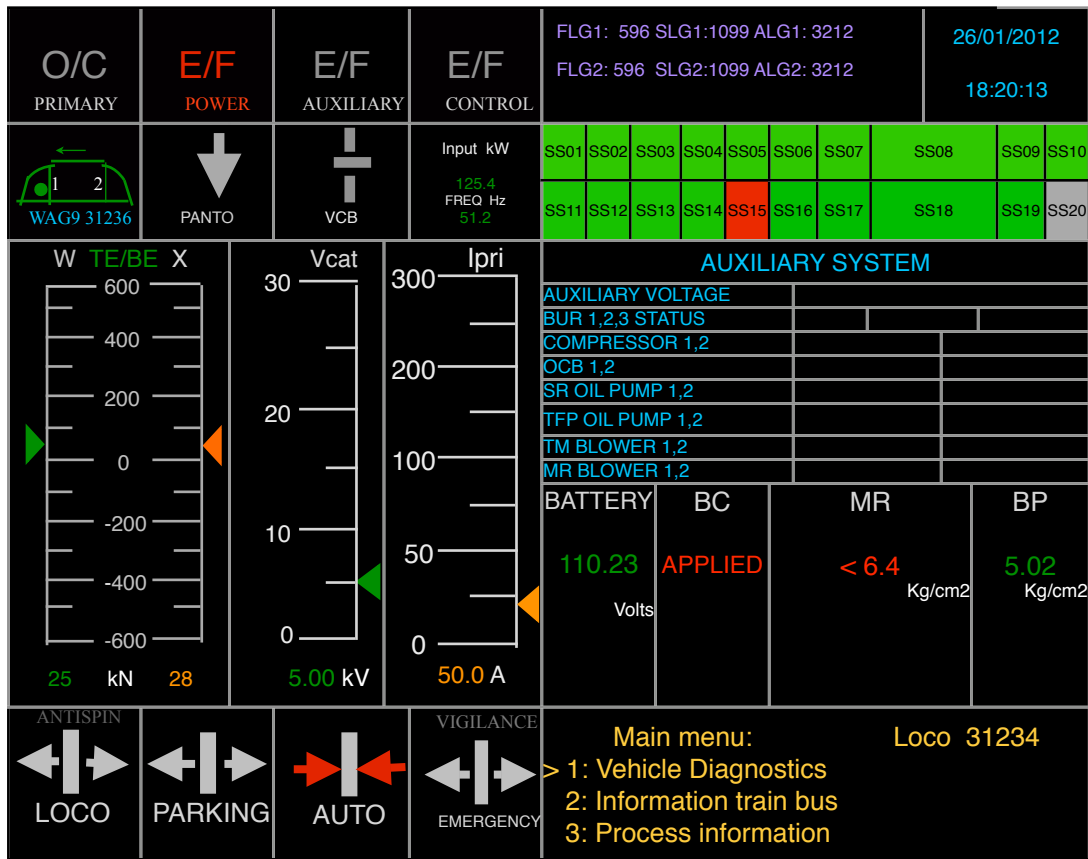

SCREEN 2.7 : BRAKING SYSTEM

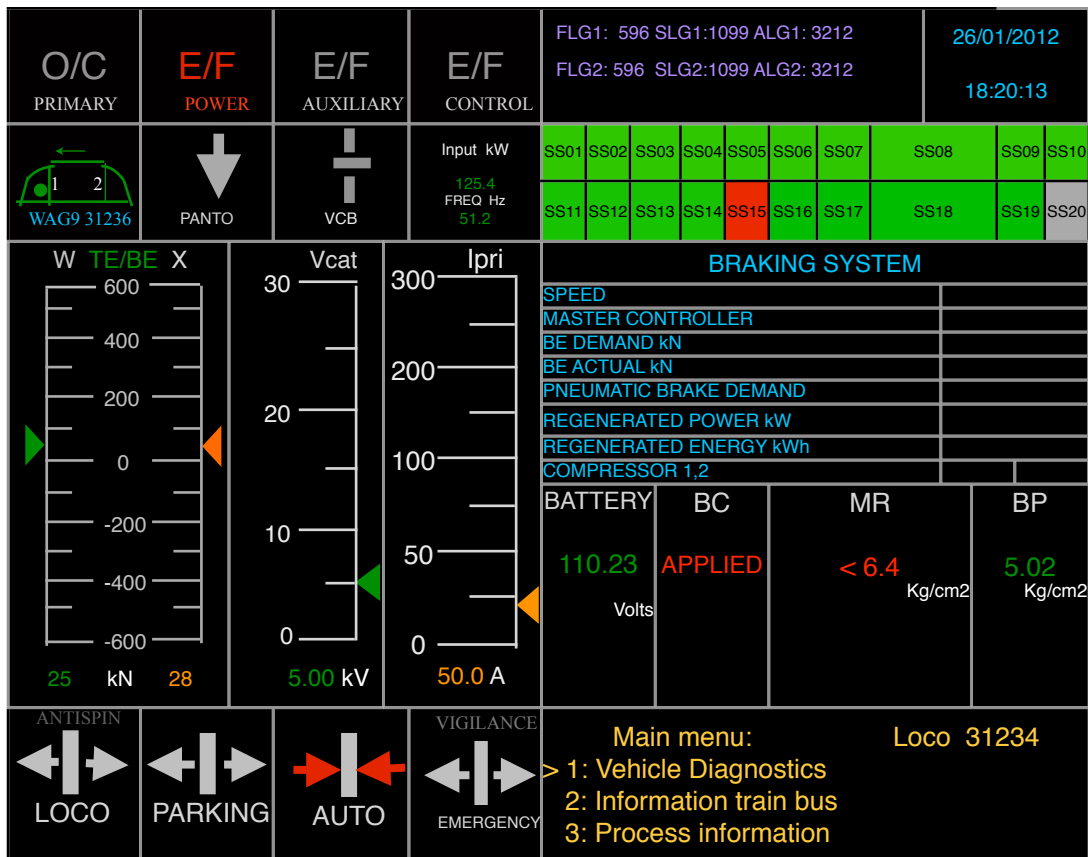

The braking system screen displays the process variables related to braking, which include locomotive speed, master controller position (traction/braking region), BE demand and BE Actual, Pneumatic Brake Effort demand (when regeneration fails), regenerated power & energy as well as status of compressor.

SCREEN 2.8 : ENERGY MONITORING

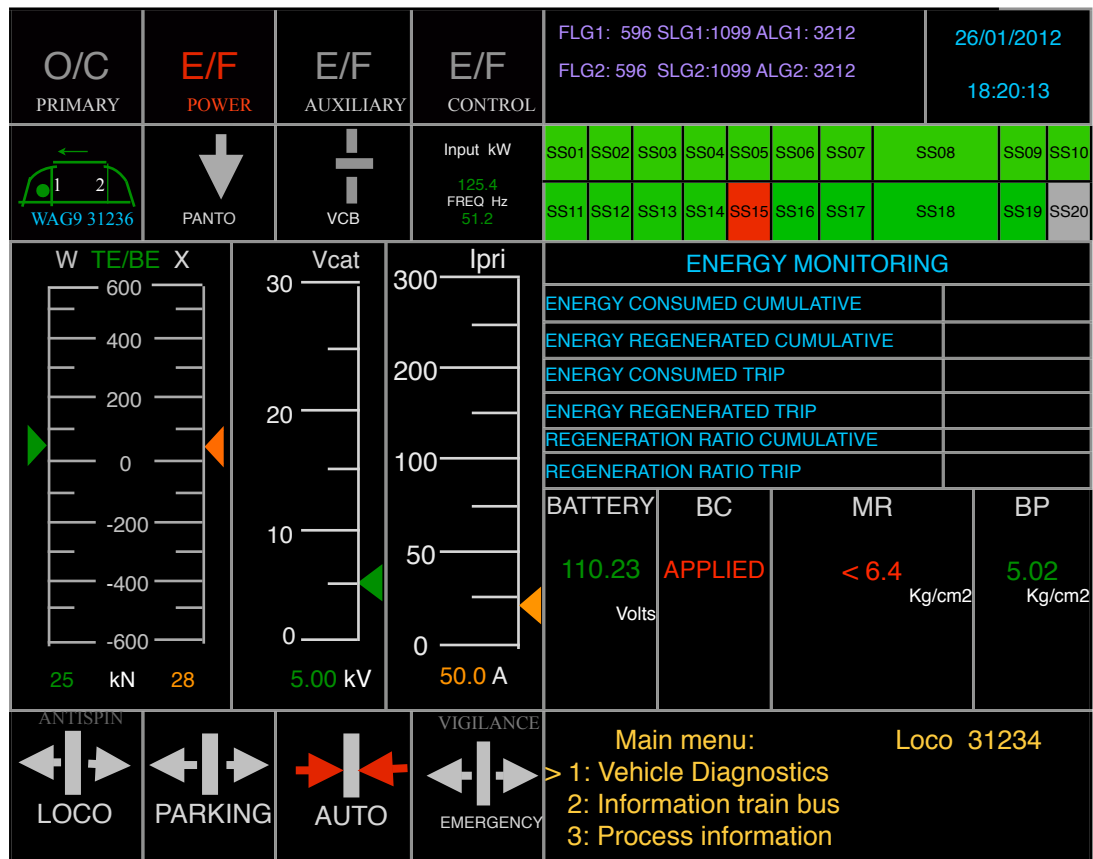

The screen for energy monitoring displays the energy consumed and regenerated. The cumulative value is the one taken from the NVRAM of DIA computer, which is available on MVB. The trip energy is calculated by the driver display itself from the time of switching ON. This value is not saved in any memory and will vanish once the locomotive is OFF. Trip energy can be used for comparison of driver performance under identical conditions of operation.

The regeneration ratio (energy regenerated/energy consumed) is calculated by the driver display and displayed. This factor also provides a measure of the efficiency of regeneration and is a good comparison tool.

SCREEN 2.9 : TEMPERATURES

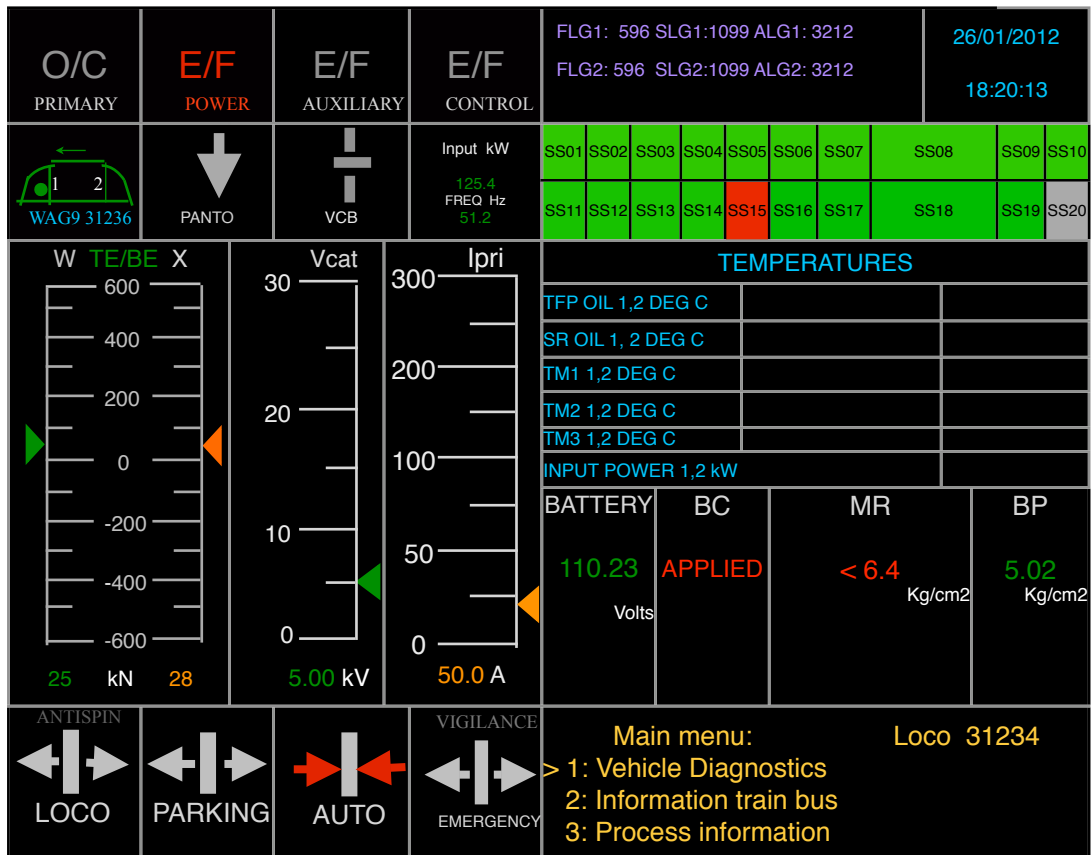

The temperature screen provides various temperatures recorded by sensors and the same can be compared with the converter input power. The temperatures of transformer oil, traction converter oil and traction motors are displayed alongwith converter input power for each bogie.

SCREEN 2.10 : PRESSURES

This screen shows the pressure variables. It include Transformer oil pressure, converter oil pressure, MR pressure, BP pressure and status of BC1 & BC2.

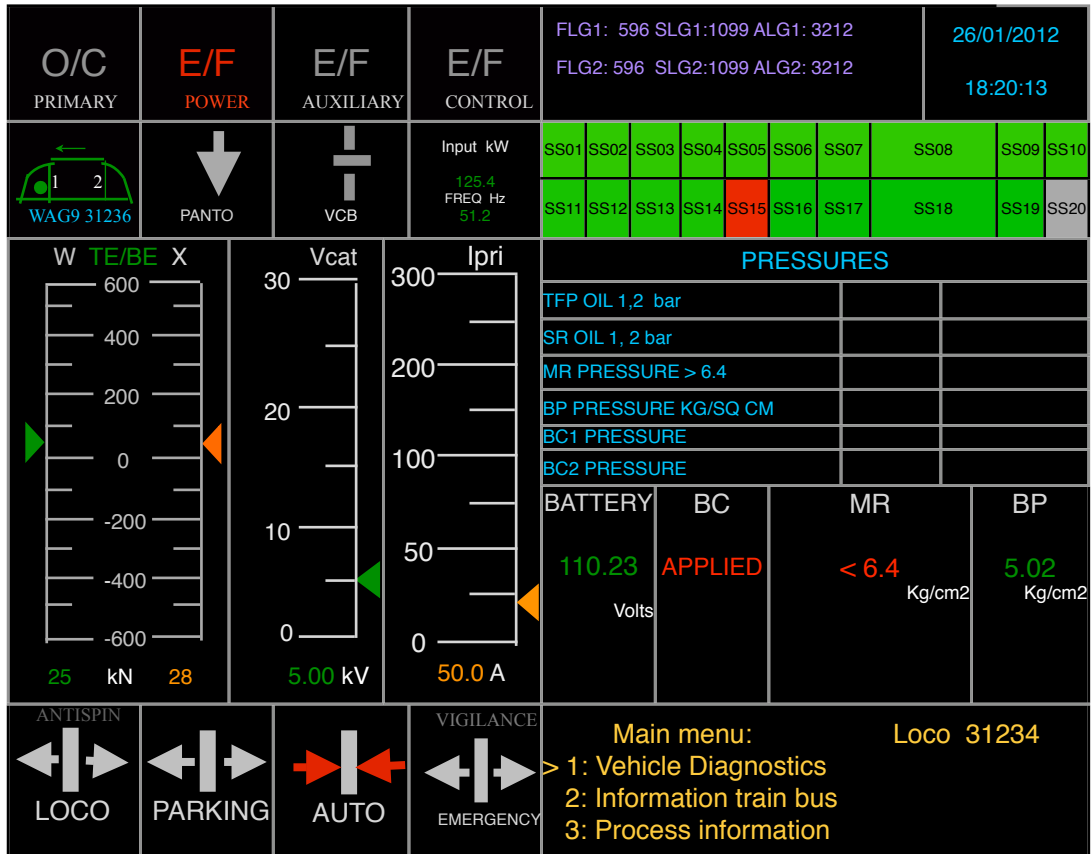

SCREEN 2.11 : ROUTE MAP

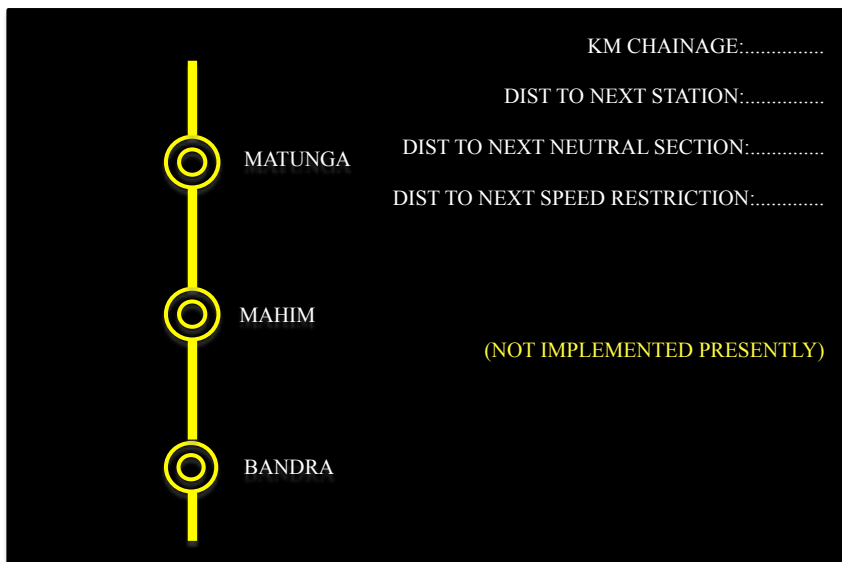

The route map is a futuristic provision given as per the specification. In the driver display, already a serial interface is provided to connect an external GPS receiver for getting the GPS co-ordinates of the location. Based on the received GPS latitude and longitude, a map can be generated using the

SIMRAN data base. This feature would be available in the future versions, when an external GPS receiver is connected and corresponding software is loaded. For full fledged implementation railway has to provide database of SIMRAN and that of neutral section locations & permanent speed restriction locations.

SCREEN 2.12 : PERMANENT SPEED RESTRICTION

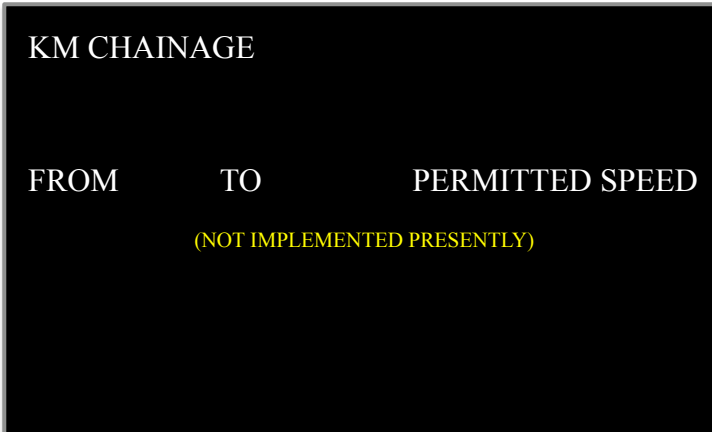

The screenshot shows a black background with white text. At the top, it says 'KM CHAINAGE'. Below that, there are three columns: 'FROM', 'TO', and 'PERMITTED SPEED'. Underneath these columns, the text '(NOT IMPLEMENTED PRESENTLY)' is displayed in yellow.

FROM	TO	PERMITTED SPEED
(NOT IMPLEMENTED PRESENTLY)		

This function is futuristic and not implemented presently. For full fledged implementation, railways have to device a mechanism to feed the en-route permanent speed restrictions into the driver display. It would also require logistics for transferring the speed restrictions en-route from a base station to a moving train.

Presently, a USB interface is provided for reading in such data. When railway is ready with a workable mechanism, this function can be activated. However, this also needs connecting a GPS receiver.

SCREEN 2.13 : DRIVER / JOURNEY DETAILS

This screen is not made active, and is reserved for future implementations. The full-fledged implementation would be available in future versions through an authentication device like a USB stick. The data has to be entered by the driver before the start of the journey. It is not mandatory to enter the data for the functioning of the equipment. This feature can help in comparison of driving performance, specific energy consumption etc.

DRIVER / JOURNEY DETAILS	
DRIVER NAME / ID	: (input)
TRAIN NAME	: (input)
TRAIN LOAD TONS	: (input)
ORIGIN CODE	: (input)
DESTINATION CODE	: (input)
SIGN IN TIME/DATE	: (input)
TRIP KM	: (calculated by system)
SPECIFIC ENERGY	: (calculated by system)

SCREEN 2.14 : INPUT/OUTPUT SIGNALS

The physical input/output signals, both analog and digital, can be viewed using this multi-level screen. In this screen, the description of the signal, name used in FUPLA and the location of the signals and the actual value can be viewed (channel+slot+connector+pin number eg: 12/EA05 : means channel-12, E slot, A connector, pin-5). These screens will be quite useful for troubleshooting.

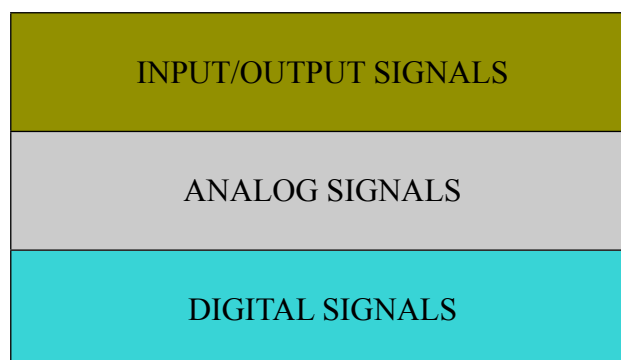

SCREEN 2.14.1 : ANALOG SIGNALS

ANALOG SIGNALS	
FLG-1	FLG-2
SLG-1	SLG-2

SCREEN 2.14.1.1 ANALOG SIGNALS – FLG1

FLG1 INPUT SIGNALS		
SIGNAL DESCRIPTION	SIGNAL NAME IN FUPLA	CHANNEL/ SLOT:CONNECTOR:PIN
Angle Transmitter	0101-XAngTrans	12/EA05
Pressure Auto Brake	0101-XPrAutoBkLn	6/EC01
FLG1 OUTPUT SIGNALS		
TE/BE Meter Bogie-1	0201-XMeterT/B1	2/EG01
TE/BE Meter Bogie-2	0201-XMeterT/B2	4/EI01

SCREEN 2.14.1.2 ANALOG SIGNALS – FLG2

FLG2 INPUT SIGNALS		
SIGNAL DESCRIPTION	SIGNAL NAME IN FUPLA	CHANNEL/ SLOT:CONNECTOR:PIN
Angle Transmitter	0101-XAngTrans	12/EA05
Pressure Auto Brake	0101-XPrAutoBkLn	6/EC01
FLG2 OUTPUT SIGNALS		
TE /BE Meter Bogie-1	0201-XMeterT/B1	2/EG01
TE/BE Meter Bogie-2	0201-XMeterT/B2	4/EI01
Pneumatic Brake Demand	0201-WPnBEdem	1/EC05

SCREEN 2.14.1.3 ANALOG SIGNALS – SLG1 (INPUTS)

SLG1 ANALOG SIGNALS		
SIGNAL DESCRIPTION	SIGNAL NAME IN FUPLA	CHANNEL/SLOT:CONNECTOR:PIN
Primary Current	0104-XAIpr	1/AA06
Total BUR Current	0104-XAIBUR	2/AC06
Filter Current	0104-XAIFilts	3/AE06
Pressure TFP Oil	0106-XADruckTR	8/AI06
Pressure SR Oil	0106-XADruckSR	12/DK07
Temperature 1 TFP Oil	0106-XATmp1OelTR	11/DI05:09
Temperature 2 TFP Oil	0106-XATmp2OelTR	10/DI06:01
Temperature1 SR Oil	0106-XATmp1OelSR	11/DG05:09
Temperature2 SR Oil	0106-XATmp2OelSR	10/DG06:01
TM1 Temperature (sensor 1)	0106-XATmp1Mot1	7/DA05:09
TM1 Temperature (sensor 2)	0106-XATmp2Mot1	6/DA06:01
TM2 Temperature (sensor 1)	0106-XATmp1Mot2	9/DC05:09
TM2 Temperature (sensor 2)	0106-XATmp2Mot2	8/DC06:01
TM3 Temperature (sensor 1)	0106-XATmp1Mot3	7/DE05:09
TM3 Temperature (sensor 2)	0106-XATmp2Mot3	6/DE06:01

SCREEN 2.14.1.4 ANALOG SIGNALS – SLG2

SLG2 ANALOG SIGNALS		
SIGNAL DESCRIPTION	SIGNAL NAME	CHANNEL/SLOT:CONNECTOR:PIN
Primary Current	0104-XAIpr	1/AA06
Total BUR Current	0104-XAIBUR	2/AC/06
Filter Current	0104-XAIFilt	3/AE06
Pressure TFP Oil	0106-XADruckTR	8/AI06
Pressure SR Oil	0106-XADruckSR	12/DK07
Temperature 1 TFP Oil	0106-XATmp1OelTR	11/DI05:09
Temperature 2 TFP Oil	0106-XATmp2OelTR	10/DI06:01
Temperature1 SR Oil	0106-XATmp1OelSR	11/DG05:09
Temperature2 SR Oil	0106-XATmp2OelSR	10/DG06:01
TM1 Temperature (sensor 1)	0106-XATmp1Mot1	7/DA05:09
TM1 Temperature (sensor 2)	0106-XATmp2Mot1	6/DA06:01
TM2 Temperature (sensor 1)	0106-XATmp1Mot2	9/DC05:09
TM2 Temperature (sensor 2)	0106-XATmp2Mot2	8/DC06:01
TM3 Temperature (sensor 1)	0106-XATmp1Mot3	7/DE05:09
TM3 Temperature (sensor 2)	0106-XATmp2Mot3	6/DE06:01

SCREEN 2.14.2 DIGITAL SIGNALS

DIGITAL SIGNALS	
HBB1	HBB2
STB1	STB2
SLG1	SLG2

SCREEN 2.14.2.1 DIGITAL SIGNALS HBB1

HBB1	
INPUT SIGNALS	GROUP 1
	GROUP 2
OUTPUT SIGNALS	GROUP 1
	GROUP 2

SCREEN 2.14.2.1.1 DIGITAL SIGNALS HBB1 INPUT GROUP 1

HBB1 DIGITAL INPUTS GROUP 1		
SIGNAL DESCRIPTION	SIGNAL NAME IN FUPLA	CHANNEL/ SLOT:CONNECTOR:PIN
Relay Control Electronics ON	0101-MRelMCEOn	2/OA09
Emergency Stop	0101-LEmgStop	3/OA02
MR Blower OK	0101-MMRBlowerOk	4/OA10
Max TE Limit	0101-LMaxTELimit	5/OA03
Banking Operation	0101-LSwBankOp	6/OA11
Compressor ON	0101-LSwComprOff	7/OA04
Compressor Direct	0101-LSwComprDir	8/OA12
Foot Switch Loco Brake	0101-LFootSwLoBk	9/OD01
Driving Direction Forward	0101-LTrvDirFor	10/OD9
Driving Direction Reverse	0101-LTrvDirRev	11/OD02
Throttle in Traction Mode	0101-LTEDemand	12/OD10
Throttle in Braking Zone	0101-LBEDemand	13/OD03
TE/BE Demand Switch > 1/3	0101-LT/BDem>1/3	14/OD11
TE/BE Demand Switch > 2/3	0101-LT/BDem>2/3	15/OD04
Push Button Fault Acknowledge	0101-LPBFaultAck	16/OD12

SCREEN 2.14.2.1.2 DIGITAL INPUTS HBB1 GROUP 2

HBB1 DIGITAL INPUTS GROUP 2		
SIGNAL DESCRIPTION	SIGNAL NAME IN FUPLA	CHANNEL/ SLOT:CONNECTOR:PIN
Auxiliary Supply Fuse Status	0102-MFuseAux	1/QA01
MCB Oil Cooling Blower 1	0102-MMCBBloCT1	2/QA09
MCB Machine Room Blower 1	0102-MMCBBloMR1	3/QA02
MCB Scavenge Blower to MR1	0102-MMCBMScBlo1	4/QA10
MCB Oil Pump SR1	0102-MMCBPumpC1	5/QA03
MCB TFP Pump 1	0102-MMCBPumpT1	6/QA11
MCB TM Blower 1	0102-MMCBBloTM1	7/QA04
MCB Scavenge to TM Blower 1	0102-MMCBTScBlo1	8/QA12
Earth Fault in 400/110V AC Circuit	0102-MEFR415/110	9/QD01
Earth Fault in Hotel Load Circuit	0102-MEFRHotel	10/QD09
VCB Status	0102-MAuxConVCB	11/QD02
VCB ON Command	0102-LVCBOn	12/QD10
Earth Fault in Filter Circuit	0102-MEFRFilter	13/QD03
Earth Fault in Control Circuit	0102-MEFRContrl	14/QD11
CoCo Detect	0102-BDetCoCo	15/QD04
BEF Model	0102-MBEFModel	16/QD12

SCREEN 2.14.2.1.3 DIGITAL SIGNALS HBB1 OUTPUT GROUP 1

HBB1 DIGITAL OUTPUTS GROUP 1		
SIGNAL DESCRIPTION	SIGNAL NAME IN FUPLA	CHANNEL/ SLOT:CONNECTOR:PIN
Fault Indication Lamp	0201-MLampFInd	1/OG19
Fault Status Lamp	0201-MLampFault	2/OG20
Buzzer Black	0201-BBuzzBlack	8/OG03
Command Self MCE	0201-BSelfMCE	12/OJ03
Contactoer Compressor 1	0201-BContCP1	14/OJ09
Buzzer Red	0201-BBuzzRed	16/OG14

SCREEN 2.14.2.1.4 DIGITAL SIGNALS HBB1 OUTPUT GROUP 2

HBB1 DIGITAL OUTPUTS GROUP 2		
SIGNAL DESCRIPTION	SIGNAL NAME IN FUPLA	CHANNEL/ SLOT:CONNECTOR:PIN
VCB ON Command (EFDJ)	0202-BVCBOnPulse	7/QJ06
Contactor Self Hold	0202-BContSelfH	12/QJ03
VCB ON Command (MTDJ)	0202-BVCBOn	13/QJ12
Contactor VCB Disable	0202-BVCBDisable	14/QJ09

SCREEN 2.14.2.2 DIGITAL SIGNALS HBB2

SCREEN 2.14.2.2.1 DIGITAL SIGNALS HBB2 INPUT GROUP 1

HBB2 DIGITAL INPUT GROUP 1		
SIGNAL DESCRIPTION	SIGNAL NAME IN FUPLA	CHANNEL/ SLOT:CONNECTOR:PIN
MCB Compressor 2	0101-MMCBCompr2	1/OA01
Emergency Stop	0101-LEmgStop	3/OA02
MR Blower OK	0101-MMRBlowerOk	4/OA10
Max TE Limit Switch	0101-LMaxTELimit	5/OA03
Switch Banking Operation	0101-LSwBankOp	6/OA11
Switch Compressor OFF	0101-LSwComprOff	7/OA04
Switch Compressor Direct	0101-LSwComprDir	8/OA12
Foot Switch Loco Brake	0101-LFootSwLoBk	9/OD01
Direction Forward	0101-LTrvDirFor	10/OD09
Direction Reverse	0101-LTrvDirRev	11/OD02
Throttle in Traction Mode	0101-LTEDemand	12/OD10
Throttle in Brake Mode	0101-LBEDemand	13/OD03
TE/BE Demand > 1/3 Switch	0101-LT/BDem>1/3	14/OD11
TE/BE Demand > 2/3 Switch	0101-LT/BDem>2/3	15/OD04
Push Button Fault Acknowledge	0101-LPBFaultAck	16/OD12

SCREEN 2.14.2.2.2 DIGITAL SIGNALS HBB2 INPUT GROUP 2

HBB2 DIGITAL INPUT GROUP 2		
SIGNAL DESCRIPTION	SIGNAL NAME IN FUPLA	CHANNEL/ SLOT:CONNECTOR:PIN
Pressure Switch Pan1	0102-MPrSwPan1	1/QA01
Pressure Switch Pan2	0102-MPrSwPan2	2/QA09
Pressure Switch Park Brake	0102-MPrSwParkBk	3/QA02
Brake Electronics OK	0102-MBrakElecOK	4/QA10
Cock Brake Control	0102-LCockBkCon	5/QA03
Emergency Brake Out	0102-LEmgBkOut	6/QA11
Pressure Switch Loco Brake	0102-MPrSwLocoBk	7/QA04
Pressure Switch Emergency Brake	0102-MPrSwEmgBk	8/QA12
Pressure Switch Air Flow	0102-MPrSwAFlow	9/QD01
Driver Command Pan Up	0102-LPanUp	10/QD09
MR Pressure > 7.5 Bar	0102-MPrSw75bar	11/QD02
Fire Alarm	0102-MFireAlarm	12/QD10
Pressure Switch Brake Cylinder 2	0102-MPrSwBkCyl2	13/QD03
Pressure Switch Low MR	0102-MPrSwLowMR	14/QD11
MR Pressure > 8 bar	0102-MPrSw8bar	15/QD04
Pressure Switch Brake Feed Pipe	0102-MPrSwBkFP	16/QD12

SCREEN 2.14.2.2.3 DIGITAL SIGNALS HBB2 OUTPUT GROUP 1

HBB2 DIGITAL OUTPUT GROUP 1		
Fault Indication Lamp	0201-MLampFInd : 1/OG19	
Fault Status Lamp	0201-MLampFault : 2/OG20	
EP Valve Auto Brake Out	0201-MLampFault : 4/OJ07	
Reset Vigilance Penalty Brake	0201-BResVigPeBk : 7/OJ13	
Buzzer Black	0201-BBuzzBlack : 8/OG03	
EP Valve Anti Spin 2	0201-BEPAntSpin2 : 12/OJ03	
Vigilance Reset	0201-BVigReset : 13/OJ12	
Vigilance Control	0201-BVigControl : 14/OJ09	
Buzzer Red	0201-BBuzzRed : 16/OG14	

SCREEN 2.14.2.2.4 DIGITAL SIGNALS HBB2 OUTPUT GROUP 2

HBB2 DIGITAL OUTPUT GROUP 2		
SIGNAL DESCRIPTION	SIGNAL NAME IN FUPLA	CHANNEL/ SLOT:CONNECTOR:PIN
EP Valve Release Parking Brake	0202-BEPRelPBk	6/QG18
EP Valve Compressor Unload	0202-BEPCPUnload	8/QG03
EP Valve sanding 1-3	0202-BEPSand13	9/QG17
EP Valve Panto1	0202-BEPPan1	10/QG23
EP Valve Sanding 2-4	0202-BEPSand24	11/QG12
Contactora Compressor 2	0202-BContCompr2	12/QJ10
Panto Disable	0202-BPanDisable	14/QJ09
EP Valve Parking Brake	0202-BEApplyPBk	15/QG22
EP Valve Loco Brake Out	0202-BEPLBkOut	16/QG14

SCREEN 2.14.2.3 DIGITAL SIGNALS STB1

SCREEN 2.14.2.3.1 DIGITAL SIGNALS STB1 INPUT GROUP 1

STB1 DIGITAL INPUT GROUP 1		
SIGNAL DESCRIPTION	SIGNAL NAME IN FUPLA	CHANNEL/ SLOT:CONNECTOR:PIN
MCB Status Compressor 1	0101-MMCBCompr1	1/JA01
Apply Parking Brake	0101-LParkBrake	2/JA09
Hotel Load Contactora Status	0101-LHotelOn	4/JA10
Cab Activating Switch in Driving	0101-LActKSwd	5/JA03
Cab Activating Switch in Cooling	0101-LActKSwdC	6/JA11
Constant Speed Button	0101-LConstSpeed	7/JA04
Hotel Load Off	0101-LHotelOff	8/JA12
Foot Switch Sanding	0101-LFootSwSand	9/JD01
Direction Forward	0101-LTrvDirFor	10/JD09
Direction Reverse	0101-LTrvDirRev	11/JD02

SCREEN 2.14.2.3.2 DIGITAL SIGNALS STB1 INPUT GROUP 2

STB1 DIGITAL INPUT GROUP 2		
SIGNAL DESCRIPTION	SIGNAL NAME IN FUPLA	CHANNEL/ SLOT:CONNECTOR:PIN
Temp Relay Control Electronics	0102-MReTempCEL	1/LA01
Cutout Switch Bogie-1	0102-LSwBogOut1	2/LA09
Cutout Switch Bogie-2	0102-LSwBogOut2	3/LA02
Switch Configuration	0102-LSwConfig	4/LA10
Switch Fail Mode	0102-LSwFailMode	5/LA03
Relay MCE On	0102-MRelMCEOn	6/LA11
Command VCB On	0102-LVCBOn	10/LD09
Key Switch Simulation	0102-LSwKSim	11/LD02
Contactor Hotel Load	0102-MContHotel	12/LD10
VCB Status	0102-MAuxConVCB	13/LD03
CoCo Detect	0102-BDetCoCo	14/LD11
Primary Current High	0102-MIPrimHigh	15/LD04

SCREEN 2.14.2.3.3 DIGITAL SIGNALS STB1 OUTPUT GROUP 1

STB1 DIGITAL OUTPUT GROUP 1		
SIGNAL DESCRIPTION	SIGNAL NAME IN FUPLA	CHANNEL/ SLOT:CONNECTOR:PIN
Lamp Wheel Slip Indication	0201-MLampWSlip	1/JG19
Lamp Constant Speed	0201-MLampCSpeed	2/JG20
Lamp Parking Brake	0201-MLampParkBk	6/JG18
Lamp Hotel Load	0201-MLampHotel	10/JG23
Air Drier Release Valve	0201-BAirDryer	12/JJ03
EP Valve Anti Spin 1	0201-BEPAntSpin1	13/JJ12
Contactor Hotel Load	0201-BContHotel	14/JJ09
Lamp Train Parting Indication	0201-MLampTPart	15/JG09

SCREEN 2.14.2.3.4 DIGITAL SIGNALS STB1 OUTPUT GROUP 2

STB1 DIGITAL OUTPUT GROUP 2		
SIGNAL DESCRIPTION	SIGNAL NAME IN FUPLA	CHANNEL/ SLOT:CONNECTOR:PIN
Relay MCE Off	0202-BRelMCEOff	1/LG07
Contactor Self MCE	0202-BSelfMCE	6/LG18
Lamp Configuration	0202-MLampConfig	8/LG03
Lamp Test	0202-BLampTest	9/LG17
VCB On Command (MTDJ)	0202-BVCBOn	10/LG23
VCB On Pulse (EFDJ)	0202-BVCBOnPulse	11/LG24
Contactor Compressor 1	0202-BContCompr1	14/LJ02
VCB Disable	0202-BVCBDisable	15/LG09
Contactor Self Hold	0202-BContSelfH	16/LG14

SCREEN 2.14.2.4 DIGITAL SIGNALS STB2

SCREEN 2.14.2.4.1 DIGITAL SIGNALS STB2 INPUT GROUP 1

STB2 DIGITAL INPUT GROUP 1		
SIGNAL DESCRIPTION	SIGNAL NAME IN FUPLA	CHANNEL/ SLOT:CONNECTOR:PIN
Apply Parking Brake	0101-LParkBrake	2/JA09
Hotel Load On	0101-LHotelOn	4/JA10
Cab Activating Switch in Drive	0101-LActKSwD	5/JA03
Cab Activating Key in Cooling	0101-LActKSwC	6/JA11
Constant Speed Button On	0101-LConstSpeed	7/JA04
Hotel Load Off	0101-LHotelOff	8/JA12
Foot Switch Sanding	0101-LFootSwSand	9/JD01
Direction Forward	0101-LTrvDirFor	10/JD09
Direction Reverse	0101-LTrvDirRev	11/JD02
Loco Speed > 105%	0101-MSpeed105%	13/JD03
Loco Speed > 110%	0101-MSpeed110%	14/JD11
Speed Alarm	0101-MSpeedAlarm	16/JD12

SCREEN 2.14.2.4.2 DIGITAL SIGNALS STB2 INPUT GROUP 2

STB2 DIGITAL INPUT GROUP 2		
SIGNAL DESCRIPTION	SIGNAL NAME IN FUPLA	CHANNEL/ SLOT:CONNECTOR:PIN
MCB Oil Cooling Blower	0102-MMCBBloCT2	1/LA01
MCB MR2 Blower	0102-MMCBBloMR2	2/LA09
MCB Scavenge MR	0102-MMCBMScBlo2	3/LA02
MCB Oil Pump SR2	0102-MMCBPumpC2	4/LA10
MCB Oil Pump2 TFP	0102-MMCBPumpT2	5/LA03
MCB TM Blower 2	0102-MMCBBloTM2	6/LA11
MCB Scavenge TM Blower	0102-MMCBTScBlo2	7/LA04
Earth Fault BUR	0102-MEFRBUR	8/LA12
Wish Pan Up	0102-LPanUp	9/LD01
Pressure Switch BC1	0102-MPrSwBkCy11	10/LD09
Smoke Warning	0102-MSmogWarn	11/LD02
Fire Equipment Failed	0102-MFailFireEq	12/LD10
Pressure Switch Emergency Brake	0102-MPrSwEmgBk	13/LD03
Pressure Switch Park Brake	0102-MPrSwParkBk	14/LD11
Vigilance Warning	0102-MVigWarn	15/LD04
Emergency Brake Vigilance	0102-MEmgBkVig	16/LD12

SCREEN 2.14.2.4.3 DIGITAL SIGNALS STB2 OUTPUT GROUP 1

STB2 DIGITAL OUTPUT GROUP 1		
SIGNAL DESCRIPTION	SIGNAL NAME IN FUPLA	CHANNEL/ SLOT:CONNECTOR:PIN
Lamp Wheel Slip	0201-MLampWSlip	1/JG19
Lamp Constant Speed	0201-MLampCSpeed	2/JG20
Lamp Park Brake	0201-MLampParkBk	6/JG18
Lamp Test Output	0201-BLampTest	7/JJ13
Lamp Hotel Load	0201-MLampHotel	10/JG23
Contactors Compressor 2	0201-BContCompr2	13/JJ12
Lower Panto	0201-BPanDisable	14/JJ09
Lamp Train Part	0201-MLampTPart	15/JG09

SCREEN 2.14.2.4.4 DIGITAL SIGNALS STB2 OUTPUT GROUP 2

STB2 DIGITAL OUTPUT GROUP 2		
SIGNAL DESCRIPTION	SIGNAL NAME IN FUPLA	CHANNEL/ SLOT:CONNECTOR:PIN
EP Valve Loco Brake Out	0202-BEPLBkOut	12/LJ03
EP Valve Compressor Unload	0202-BEPCPUnload	13/LJ12
EP Valve Panto 2	0202-BEPPan2	14/LJ09

SCREEN 2.14.2.5 DIGITAL SIGNALS SLG1

SLG1 DIGITAL SIGNALS
INPUT SIGNALS
OUTPUT SIGNALS

SCREEN 2.14.2.5.1 DIGITAL SIGNALS SLG1 INPUT

SLG1 DIGITAL INPUTS		
SIGNAL DESCRIPTION	SIGNAL NAME IN FUPLA	CHANNEL/ SLOT:CONNECTOR:PIN
Input Contactor	0103-MLdSEin	9/WD01
Filter Discharge Contactor	0103-MFiltDhcOn	10/WD09
Filter Contactor	0103-MFiltOn	11/WD02
Filter Adaptation Contactor	0103-MFiltAdpOn	12/WD10
Protective Shutdown Wire	0103-MHS-HalteKr	13/WD03
DC Link Capacitor Pressure	0102-MDruCZK	14/WD11
Pre-Charging Contactor	0103-MSRSEin	15/WD04
External Protective Turn Off Wire	0103-MExtRLgez	16/WD13

SCREEN 2.14.2.5.2 DIGITAL SIGNALS SLG1 OUTPUT

SLG1 DIGITAL OUTPUTS		
SIGNAL DESCRIPTION	SIGNAL NAME IN FUPLA	CHANNEL/ SLOT:CONNECTOR:PIN
Filter Contactor	8501-BFiltOn	1/WG19:07
Filter Adaptation Contactor	8501-BFiltAdpOn	2/WG20:07
Filter Discharge Contactor	8501-BFiltDhcOn	3/WG08:07
Pre-Charging Contactor	8702-BSRSEin	4/WG02
Input Contactor	8701-BLdSEin	5/WG24:12
Protective Turn Off Wire	0870-BExtRLabtr	6/WG21:09
GUSP Contactor	8601-BGUSpEin	7/WG10:23
External Protective Turn Off	0870-BHS-HalteKr	8/WG06:18

SCREEN 2.14.2.6 DIGITAL SIGNALS SLG2

SLG2 DIGITAL SIGNALS
INPUT SIGNALS
OUTPUT SIGNALS

SCREEN 2.14.2.6.1 DIGITAL SIGNALS SLG2 INPUT

SLG2 DIGITAL INPUTS		
SIGNAL DESCRIPTION	SIGNAL NAME IN FUPLA	CHANNEL/ SLOT:CONNECTOR:PIN
Input Contactor	0103-MLdSEin	9/WD01
Filter Discharge Contactor	0103-MFiltDhcOn	10/WD09
Filter Contactor	0103-MFiltOn	11/WD02
Filter Adaptation Contactor	0103-MFiltAdpOn	12/WD10
Protective Shutdown Wire	0103-MHS-HalteKr	13/WD03
DC Link Capacitor Pressure	0102-MDruCZK	14/WD11
Pre-Charging Contactor	0103-MSRSEin	15/WD04
External Protective Turn Off Wire	0103-MExtRLgez	16/WD13

SCREEN 2.14.2.6.2 DIGITAL SIGNALS SLG2 OUTPUT

SLG1 DIGITAL OUTPUTS		
SIGNAL DESCRIPTION	SIGNAL NAME IN FUPLA	CHANNEL/ SLOT:CONNECTOR:PIN
Filter Contactor	8501-BFiltOn	1/WG19:07
Filter Adaptation Contactor	8501-BFiltAdpOn	2/WG20:07
Filter Discharge Contactor	8501-BFiltDhcOn	3/WG08:07
Pre-Charging Contactor	8702-BSRSEin	4/WG02
Input Contactor	8701-BLdSEin	5/WG24:12
Protective Turn Off Wire	0870-BExtRLabtr	6/WG21:09
GUSP Contactor	8601-BGUSpEin	7/WG10:23
External Protective Turn Off	0870-BHS-HalteKr	8/WG06:18

Screen 15 : Context Sensitive Trouble Shooting Guide

The driver display is loaded with a context sensitive trouble shooting guide. Whenever a fault is triggered, the corresponding trouble shooting instructions, as approved by RDSO, will get popped up on the screen. This will help the driver in dealing with the situation effectively.

6. IMPORTANT

This is a sophisticated microprocessor based equipment and can be serviced only by trained skilled personnel. Opening the equipment by any unauthorized person can partially or fully damage the equipment and will make the warranty null and void.

